

Hydraulic Arm Application Guide

© TeacherGeek™, 2011



QUICK-START GUIDE

- ❑ The *TeacherGeek Quick-Start Guide* provides a great reference for techniques, tools and tips used to assure successful building.
- ❑ Before beginning construction, take time to review this important information..

Click on this image to open the full PDF document. 



QUICK-START GUIDE

Built it, try it, change it. TeacherGeek™ components allow you to design and engineer your most imaginative mechanisms. Combine them with other materials and products. More resources are available at teachergeek.com.

DOWELS



Dowels vary in diameter. Some may be too large or small to use.

The ends of dowels may taper and need to be cut off to fit tightly into holes.

CUTTING



Dowels and Connector Strips can be cut with a multi-cutter (best method), saw, side cutters or pruning shears. Wear safety glasses when cutting.

HOLES & REAMING



Reaming holes to allow dowels to rotate and slide freely.

Components come with holes that dowels press securely into.

Turn a reamer back and forth through a hole.

PUSH, WIGGLE, TAP

Push dowels into holes by:

1. Wiggling and pressing with your hands
2. Tapping dowels with a hammer or the side of your cutter.



Tip: Rubbing a dowel with soap or wax allows it to slide easier into holes.



WARNING!!! Most holes should not be reamed. Do not ream holes which dowels should stay pressed into.

EXAMPLE ASSEMBLY

An example mechanism with two gears that turn together in a frame.



1. Connector strips and dowels are cut. Then they are assembled to make the frame.
3. Holes in the frame are reamed for the gear axles to rotate in.



Use slide stop or stop clips to keep dowels from sliding in reamed holes.

On / Off

Stop Clip

Slide Stop

5. Slide stop and a stop clip are put on axles to keep them from sliding out of the reamed holes.



2. Dowels are cut to make axles and pushed into gears.



4. Gear axles are placed through the reamed holes.
6. Cranks are attached.

Construction System Patent Pending. © TeacherGeek Inc. 2011

HYDRAULIC ARM PARTS

PART	QUANTITY	DISCRIPTION
A	5	CONNECTOR STRIPS
B	3	HOLE PLATES
C	5	12" DOWELS
D	7	PERPENDICULAR ADAPTORS
E	7	10 ML SYRINGES
F	3	10 ML SYRINGE CLIPS
G	3	10 ML SYRINGE MOUNTS
H	1	3 ML SYRINGE
I	1	3 ML SYRINGE CLIP
J	1	3 ML SYRINGE MOUNT
K	1	CONTROL PANEL
L	3	STOP CLIPS
M	15'	VINYL TUBING
N	1	10-24 X 1 1/2" PAN HEAD MACHINE SCREW
O	6	10-24 X 1" PAN HEAD MACHINE SCREW
P	8	10-24 HEX NUTS
Q	1	10-24 LOCKING HEX NUT
R	4	#16 RUBBER BANDS
S	2	#10 WASHERS

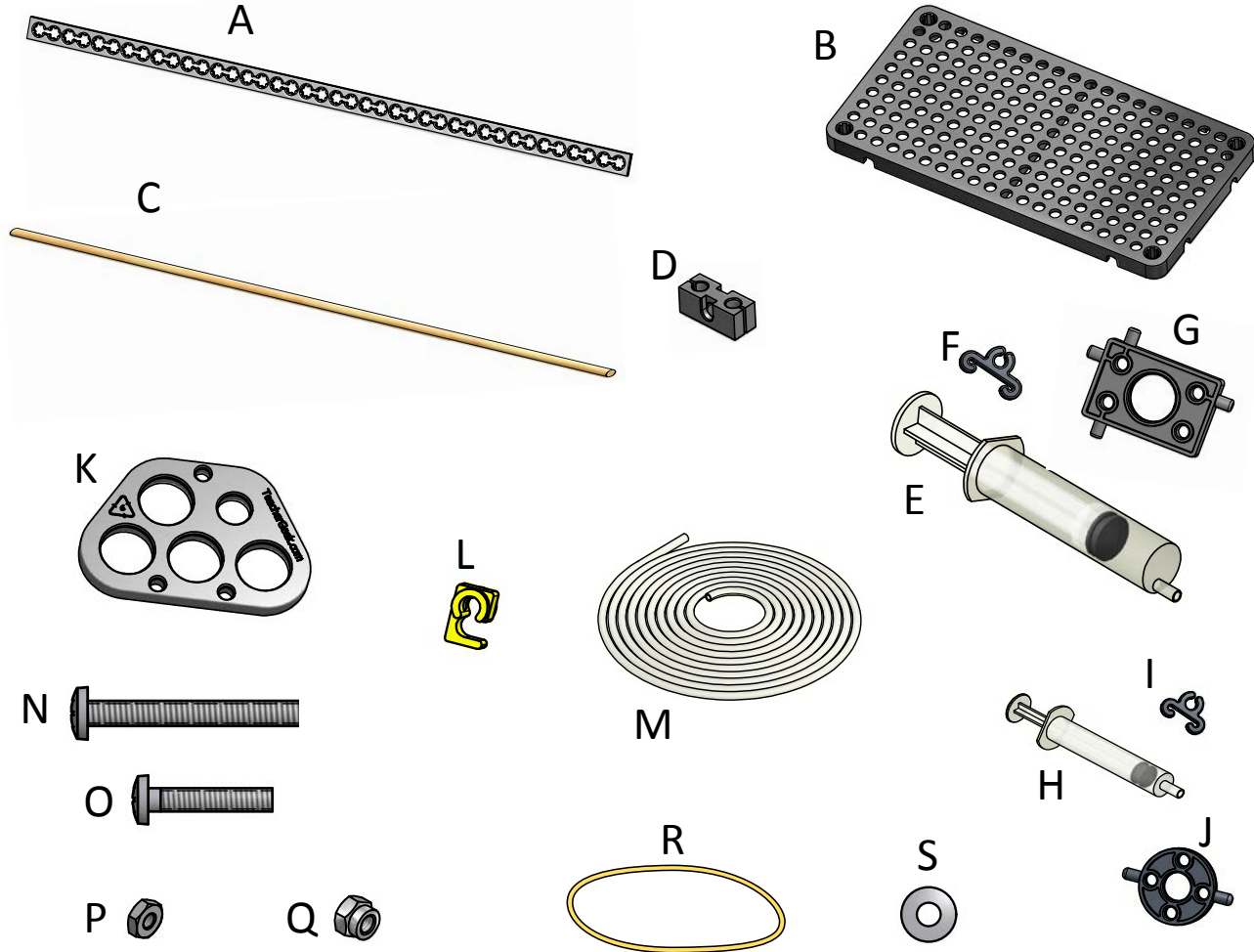

CREATE BASE PLATFORM

- 1
- ❑ Cut one 300mm connector strip into two equal 150mm pieces.

- 2
- ❑ Using four 10-24 x 1" machine screws and hex nuts, assemble the support legs to the ends of the hole plate on both sides as shown.
 - ❑ Cut one dowel to 170mm (~6 3/4"). Insert into both end holes of connector strips.

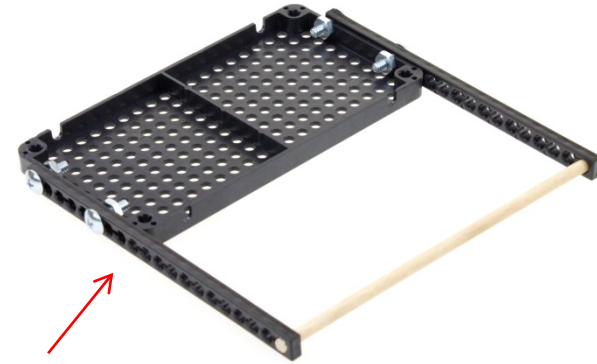

Finished Bottom View

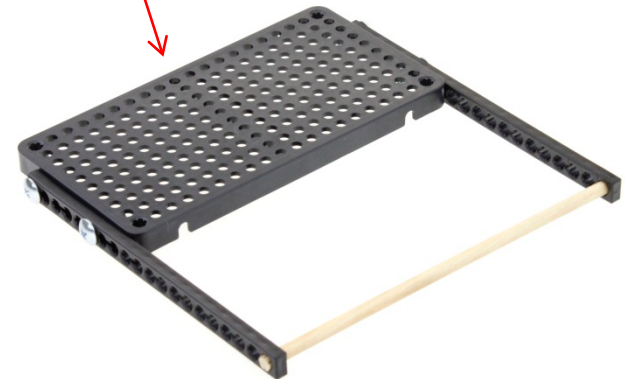

Finished Top View



Don't Ream

CREATE ROTATING ARM SUPPORT

- 3** Lay two hole plates bottom side up on a flat surface.

- 4** Cut three dowels 51mm (~2")
 Insert dowels into corners as shown.
 Slide one perpendicular adaptor on to the corner dowel as shown.

- 5** Place the other hole plate over the dowels and insert the syringe mount into the hole that is down four holes from the top and in three holes from the side as shown.
 Tip: Syringe mount is placed in the corner area with no dowels. Be sure to install the mount in the horizontal direction as shown.

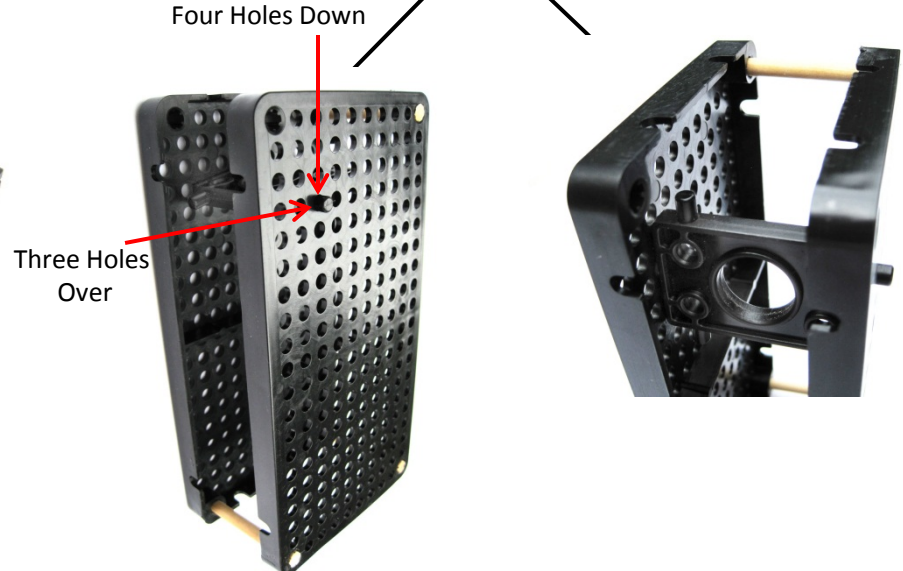
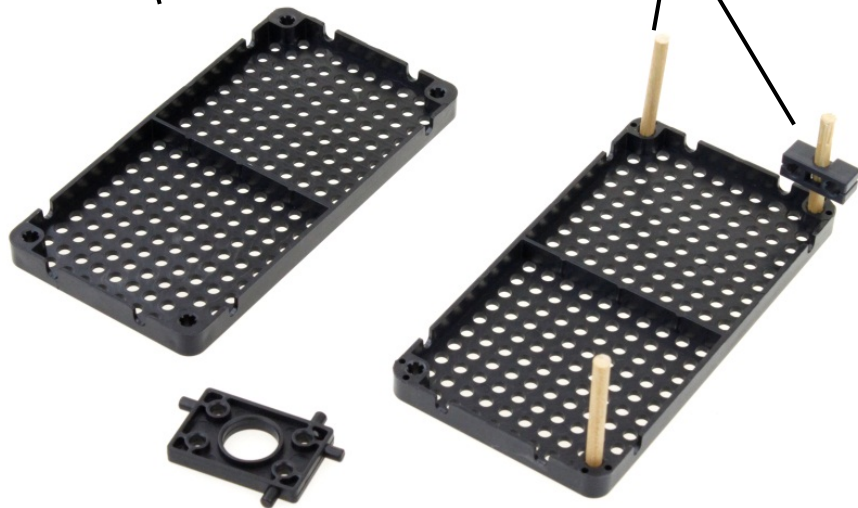

ATTACHING SWIVEL ARM SUPPORT TO BASE

6 Place 10-24 x 1" machine screw from the bottom of the base through the hole that is 9 holes over in the 2nd row as shown. Place two #10 washers over the bolt.

7 Place the inside hole of the perpendicular adaptor that is mounted to the swivel arm support over the washers on the machine screw.

8 Place 10-24 locking hex nut on the screw and tighten.
 Loosen the locking nut just enough so the swivel arm support can rotate freely.

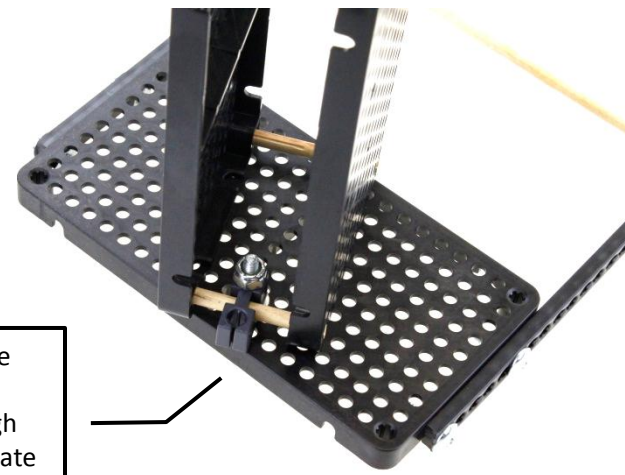
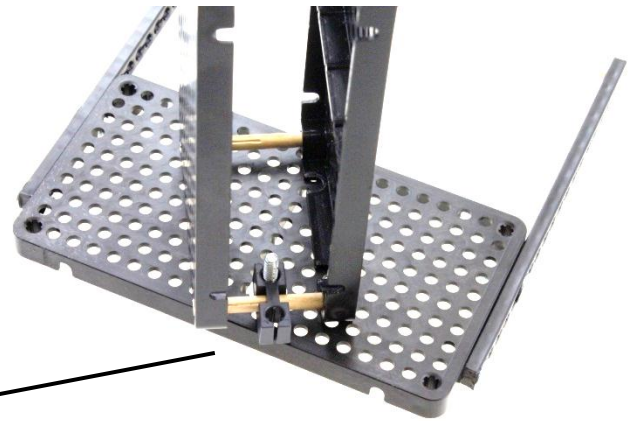

2nd row

9 holes over



BUILDING THE LOWER COMPONENT OF THE ARM

9

- Cut three dowels 76mm (~3").
- Ream the holes on two large syringe clips.
- Slide large syringe clips on two of the dowels.
- To assemble as shown insert a dowel with syringe clip into the first holes on both 300mm connector strips. Now insert a dowel (without a syringe clip) into the 20th holes of the connector strips. Finally insert a dowel with a syringe clip into the 26th holes of the connector strips.
- Ream the 8th hole on both connector strips as shown.
- Ends of all dowels need to extend 6mm (~1/4").

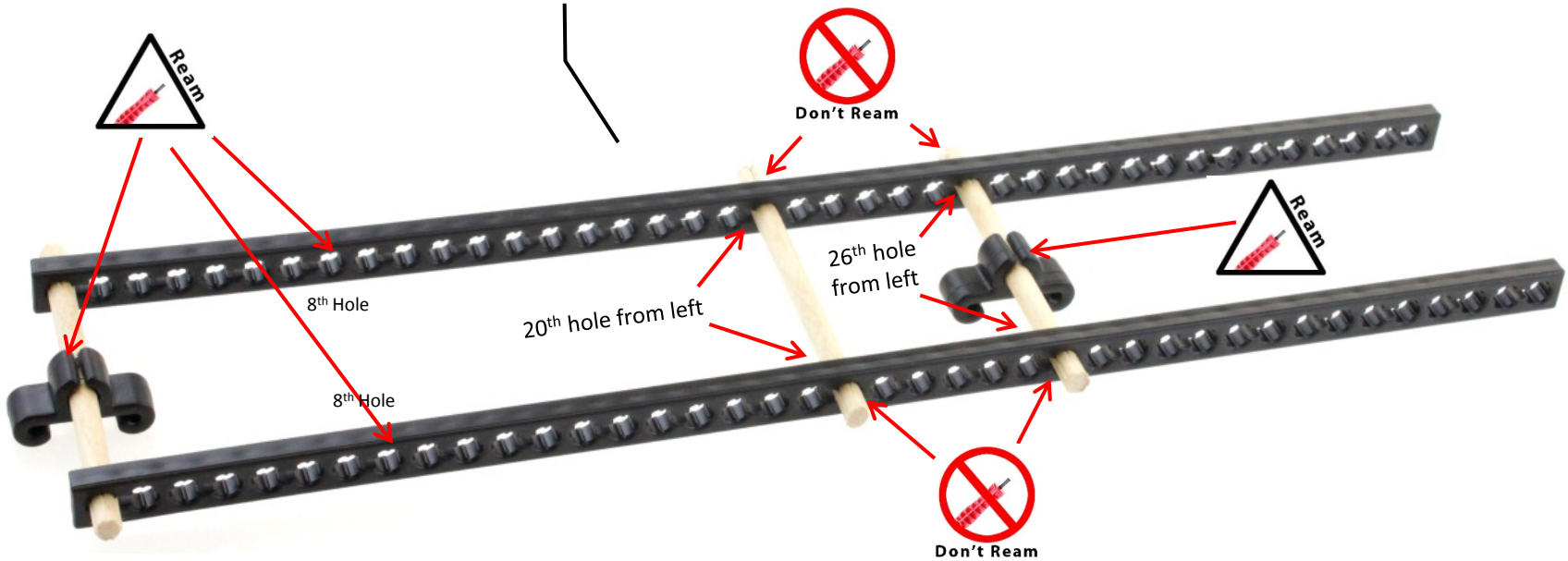

BUILDING THE UPPER COMPONENT OF THE ARM

10

- ❑ Cut two dowels 51mm (~2").
- ❑ Assemble two full connector strips with the cut dowels in the 7th and 21st holes as shown.
- ❑ Dowel ends should extend beyond the connector strips by 6mm (~1/4").

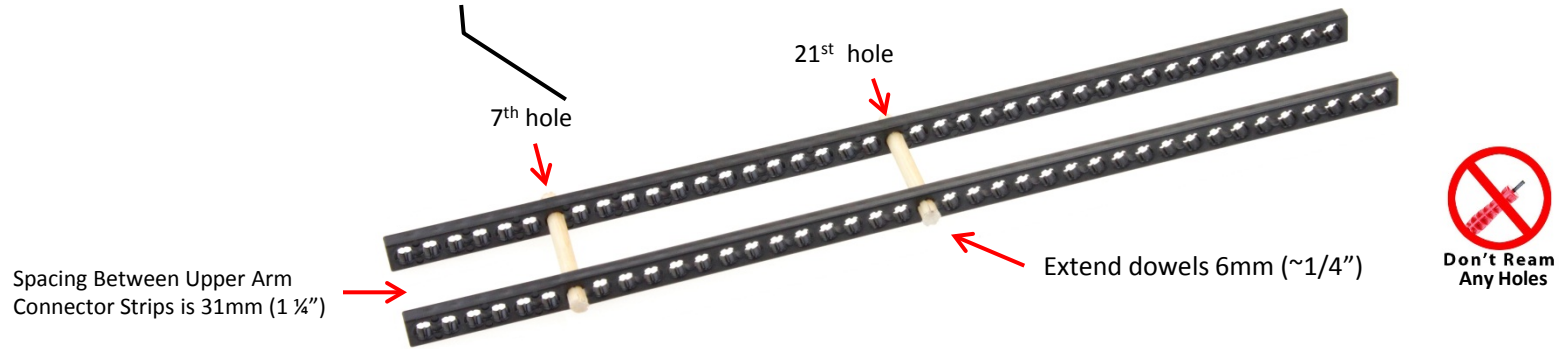

11

- ❑ Cut 45mm (~1 3/4") off one connector strip as shown.



JOINING THE LOWER AND UPPER ARM COMPONENTS

12

- ❑ Cut one dowel 90mm (~3 1/2").
- ❑ Insert the 90mm (3 1/2") dowel through one reamed hole (8th from end) of the lower arm section. Then into both of the unreamed 7th holes of the upper arm component. Finally insert the dowel through the reamed hole of the lower arm component.
- ❑ Spacing between the upper arm connector strips should be 31mm (~1 1/4").
- ❑ Place Teacher Geek Clips on both ends of the dowel.

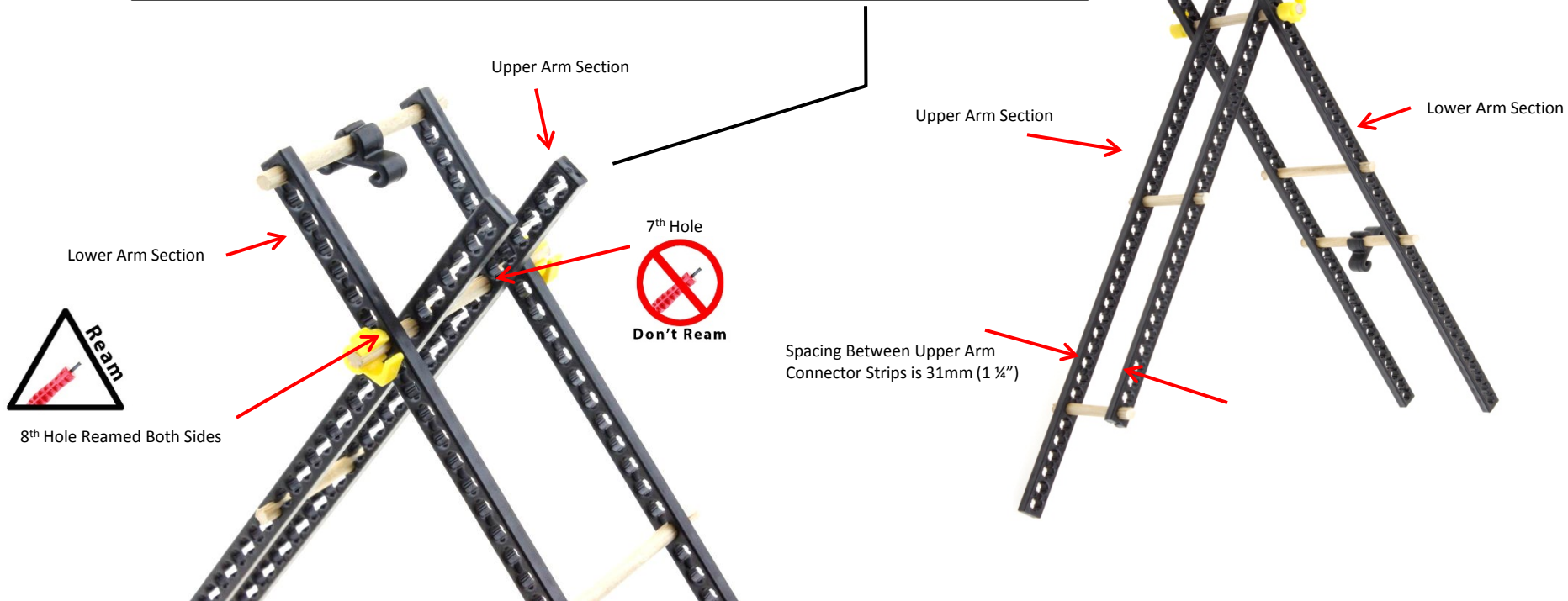

ATTACHING ARM TO THE SWIVEL BASE

- 13
- ❑ Cut one dowel 76mm (~3").
 - ❑ Insert dowel through holes as shown so equal amounts of dowel extend past the hole plates.

Top hole of third vertical row in.

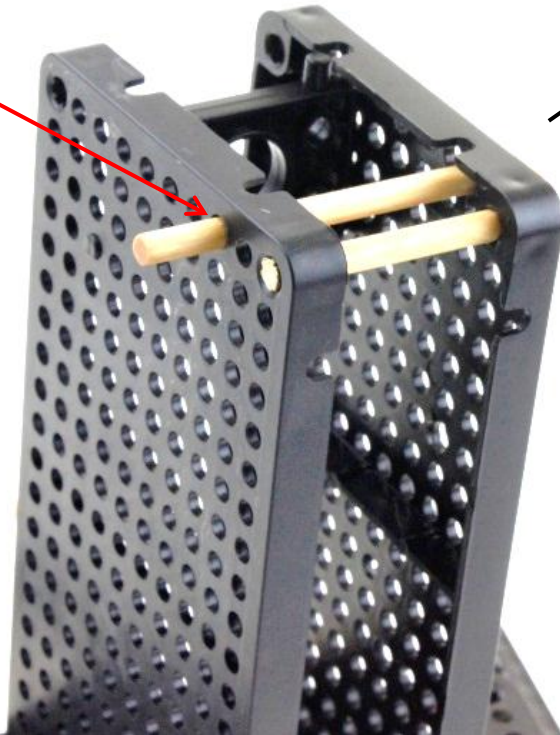

- 14
- ❑ To attach the arm to the base insert the extending dowel ends through the 6th holes on the lower arm section.

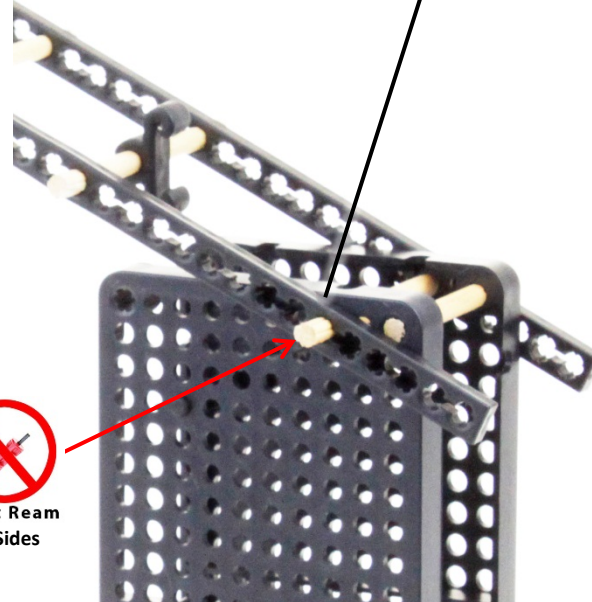

 Don't Ream Both Sides

INSTALLING 10ML SYRINGE ON ARM

15

- ❑ Place syringe mount pins into the 3rd hole from the end of the upper arm component.
- ❑ Press 10ml syringe into the syringe mount and slide the end of the syringe into the clip as shown.

Syringe Mount

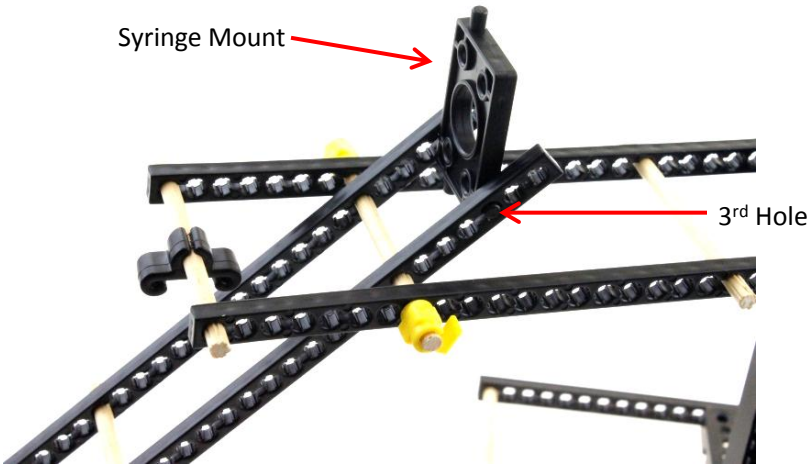

Don't Ream
Any Holes



INSTALLING 10ML SYRINGE IN SWIVEL BASE

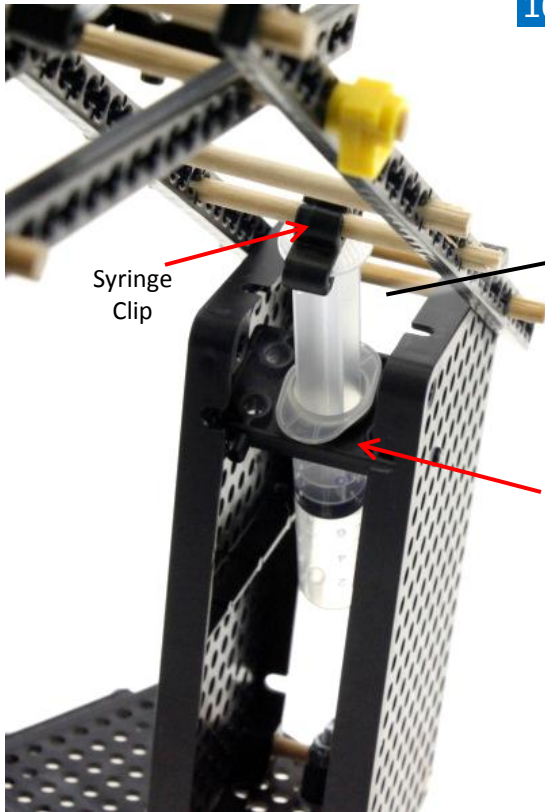

16

- ❑ Press 10ml syringe into the syringe mount in the swivel base and slide the end of the syringe into the clip as shown.



Don't Ream



INSTALLING 10ML SYRINGE IN SWIVEL BASE

- 17**
- Cut dowel 76mm (~3").
 - Place in corner hole of base as shown.



- 18**
- Place 10cc syringe mount in the 3rd hole from the corner on support leg side in the vertical position as shown.
 - Slide a perpendicular adaptor over the dowel and onto the syringe mount pin as shown.

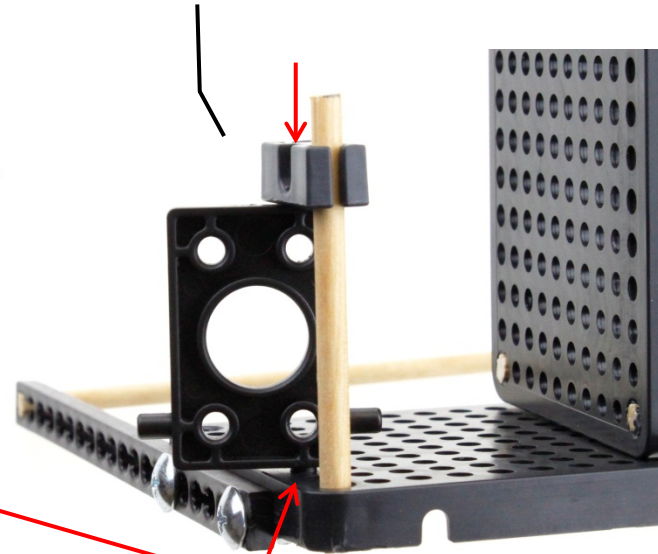

Third hole from corner

INSTALLING 10ML SYRINGE ON SWIVEL BASE

19

- ❑ Insert a 10-24 x 1.5" machine screw from the inside out in the 6th hole up in the first vertical row as shown.
- ❑ Install a 10-24 hex nut and tighten to the hole plate.
- ❑ Thread a 2nd hex nut onto the machine screw leaving a 19mm (~3/4") space between the hex nuts.
- ❑ Cut dowel 39mm (~1 1/2") and insert into the center hole of a perpendicular adaptor.
- ❑ Slide an end hole of the perpendicular adaptor on the machine screw so that it contacts the hex nut.
- ❑ Install another 10-24 hex nut and tighten securely on the perpendicular adaptor.

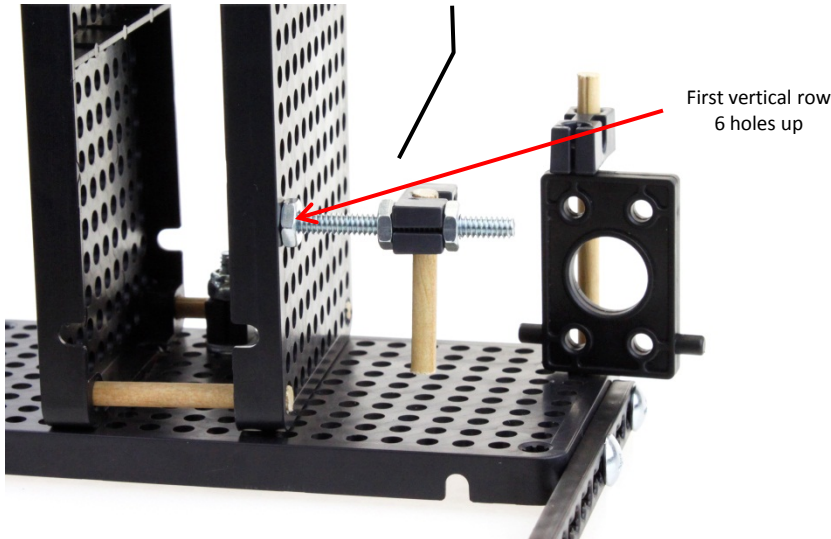

20

- ❑ Ream a large syringe clip and slide over the end of a 10ml syringe.
- ❑ Press syringe into the syringe mount installed on the base and slide the reamed syringe clip up on to the dowel as shown.

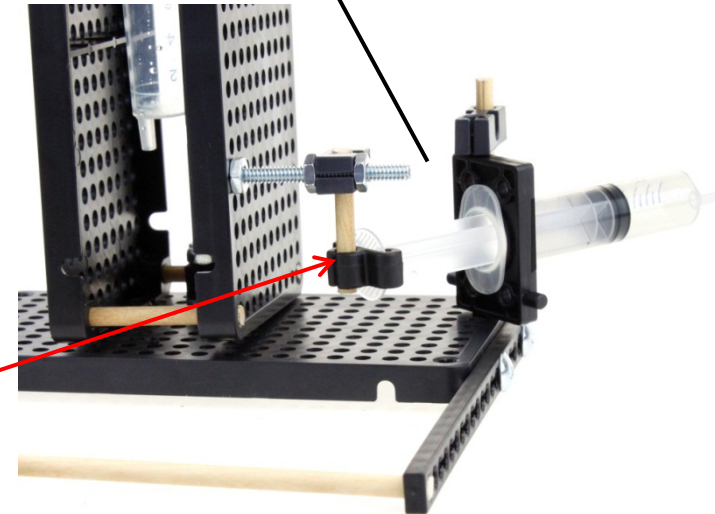

BUILDING THE GRIPPER

- 21
- ❑ Insert 3ml syringe into a 3ml syringe holder.
 - ❑ Place a 10-24 x 1" machine screw into the syringe holder and into the 4th hole of the longer connector strip of the upper arm component.
 - ❑ Tighten securely with a 10-24 hex nut.

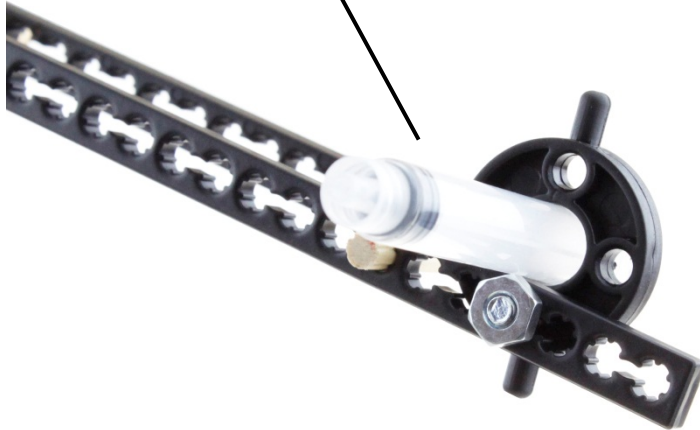

- 22
- ❑ Cut dowel 90mm (~4 1/2").
 - ❑ Slide the dowel in the last hole of the connector strip so that it extends 13mm (~3/4") to the outside.
 - ❑ Over that 13mm (~3/4") extension slide a perpendicular adaptor through its center hole. The dowel will still extend beyond the adaptor.

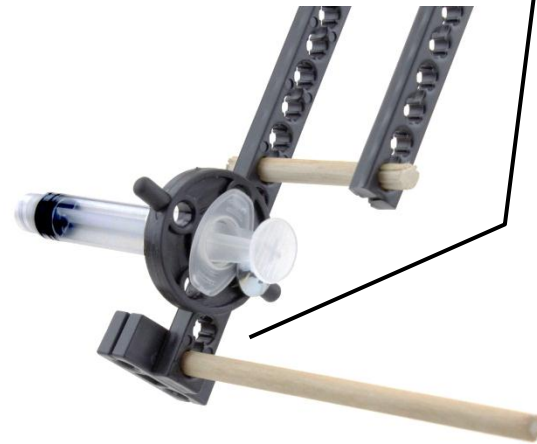

FINISH BUILDING THE GRIPPER

- 23**
- Cut dowel 90mm (~3 1/2").
 - Slide this dowel in the end hole of a perpendicular adaptor.
 - Slide this dowel and adaptor into the top hole of the adaptor already installed on the gripper as shown.

- 24**
- Cut a dowel 115mm (~4 1/2").
 - Slide the dowel through the center hole of a perpendicular adaptor so 25mm (1") extends through the other side.
 - Slide a small syringe clip over the other end as shown.
 - Ream the hole shown in the perpendicular adaptor that is closest to the syringe clip.

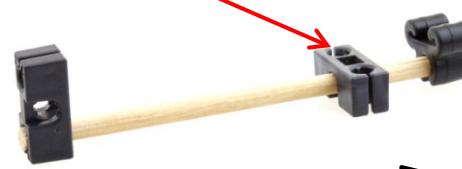

- 25**
- Slide the reamed hole of the assembly in step 20 over the gripper dowel as shown.
 - Install the small syringe clip over the end of the syringe.
 - Place a Teacher Geek Clip on the end of the dowel as shown.

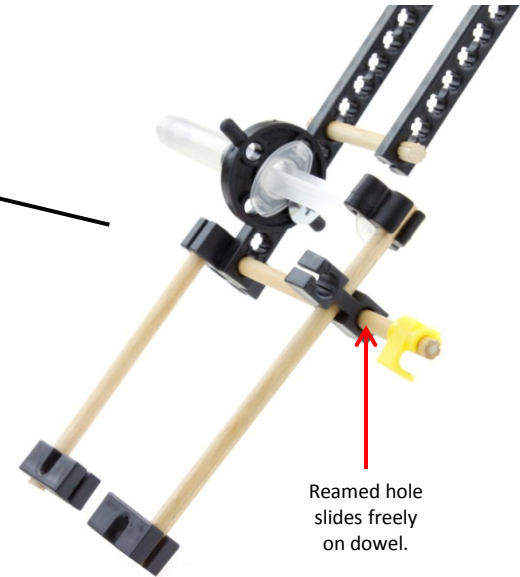

Reamed hole slides freely on dowel.

CUT VINYL TUBING TO LENGTH

- 26 Cut four lengths of tubing as indicated below.



80cm (~32 in.) BASE MOUNTED ROTATING SYRINGE TUBING



80cm (~32 in.) LOWER ELEVATING SYRINGE TUBING



110 cm (~42 in.) MID ARM SYRINGE TUBING



140cm (~54 in.) GRIPPER SYRINGE TUBING



FILLING SYRINGES AND TUBING

Water coloring is optional.

- 27
- Place fully depressed syringe into water.
 - Draw a full 10 ml into the syringe.

- 28
- Place tubing over end of syringe and other end into the water.
 - Depress syringe fully to fill tubing.

- 29
- Keeping the end of the tubing in the water, draw a full 10ml of water into the syringe.

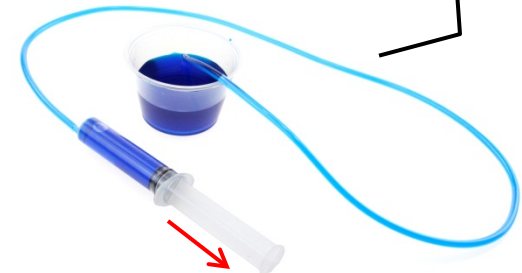
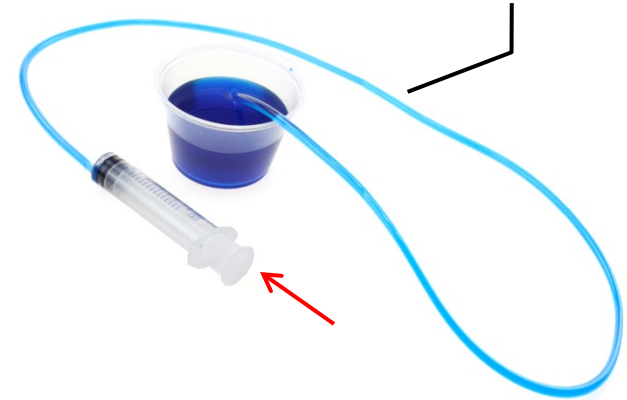
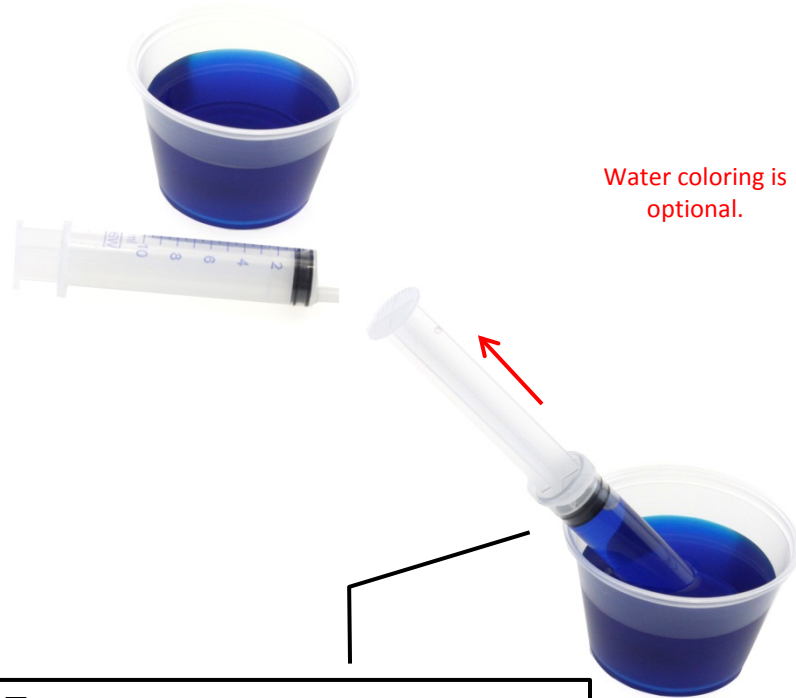

FILLING SYRINGES AND TUBING

30 Push the mounted syringe plunger all the way in as shown.

31 Place end of filled tube on to the base mounted syringe.

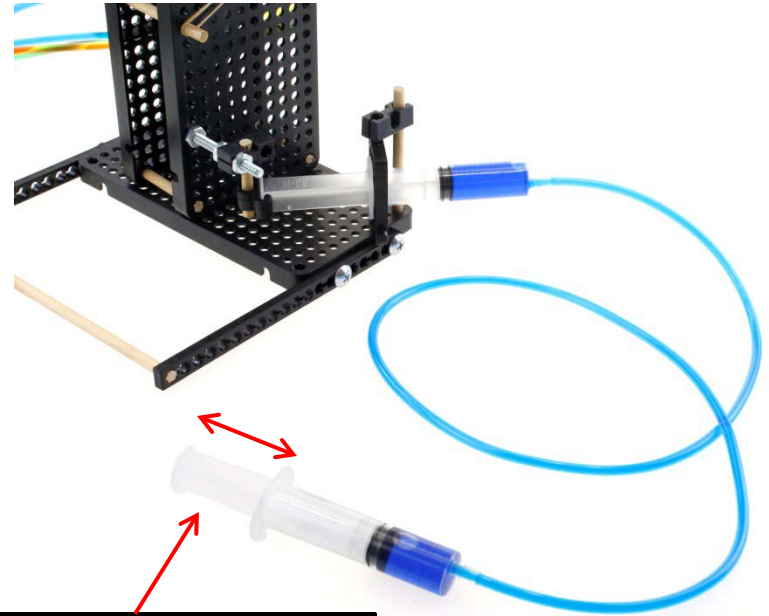
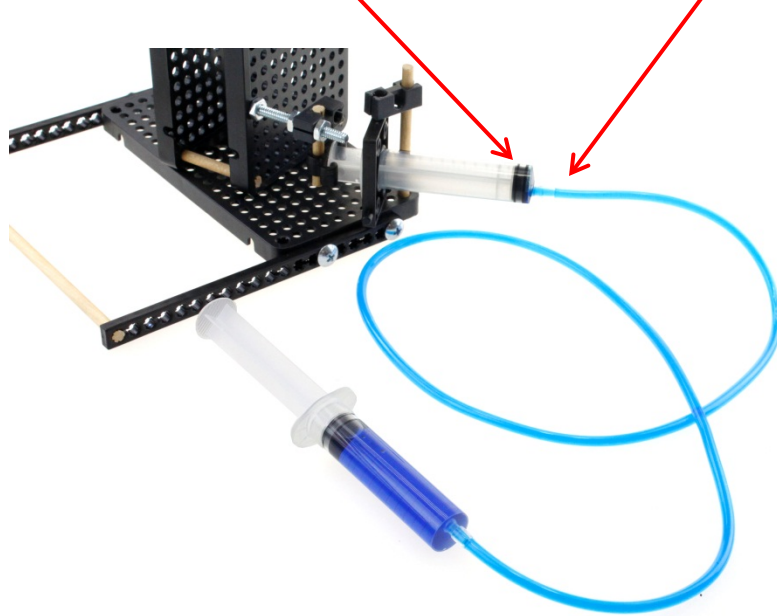

32 Push and pull the control syringe to rotate the rotating base.



INSTALLING SYRINGES INTO CONTROL PANEL

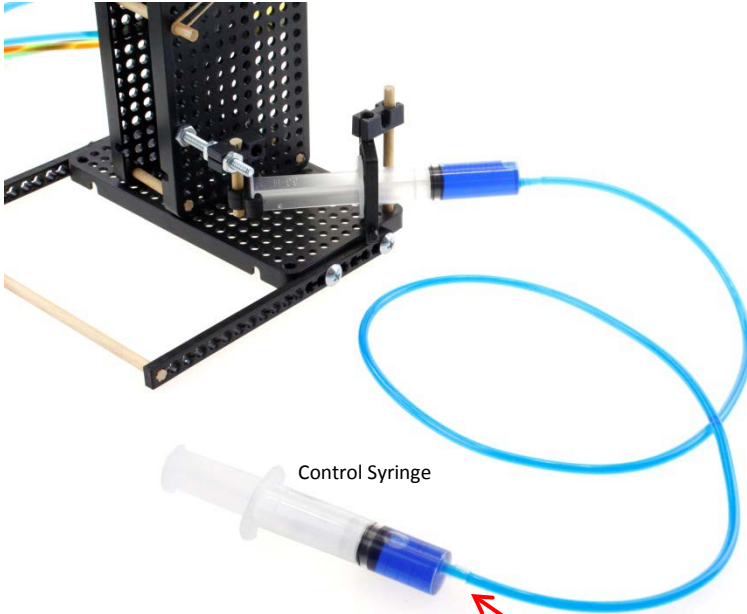

Control Panel

- 33** Carefully disconnect filled tubing from control syringe.

- 34** Insert syringe into a hole on control panel.

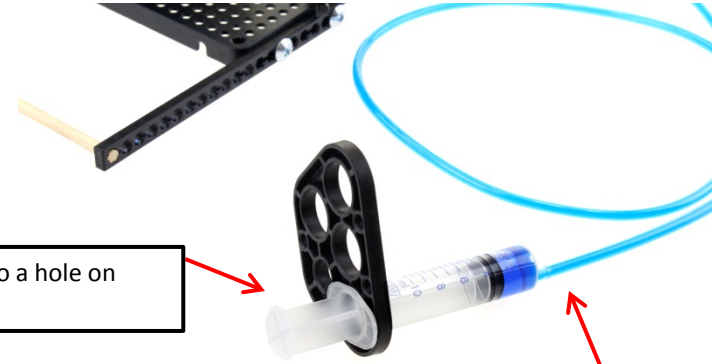

- 35** Squeezing the end of the tubing to remove any air bubbles, slide back on to the control syringe.

- 36** Repeat with the three remaining control syringes.
 The gripper syringe is only 3ml so when filling the 10ml control syringe, stop at 3ml.

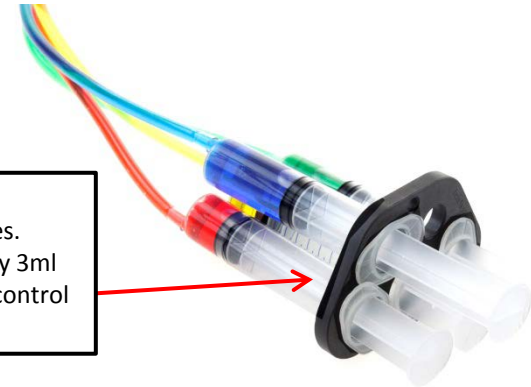

SECURE THE TUBING TO ARM

IMPORTANT TIPS

- ❑ Leave the ties slightly loose so they do not restrict the water flow through the tubes.
- ❑ Be sure the tubing has enough slack so as to not restrict the movement.

- 37
- ❑ Using twist ties or zip ties, secure the tubing to arm. Also group together the four tubes going to control panel.

80cm Tubing

110cm Tubing

140cm Tubing

Both 80cm tubing sections go from control panel to the arms lower cylinders.

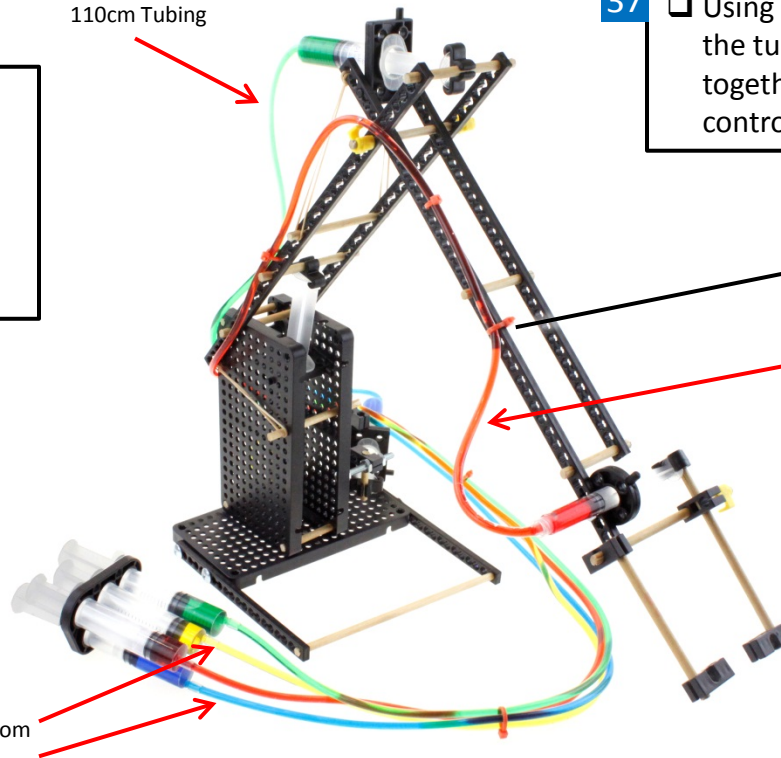

CREATING COUNTER BALANCE WITH RUBBER BANDS

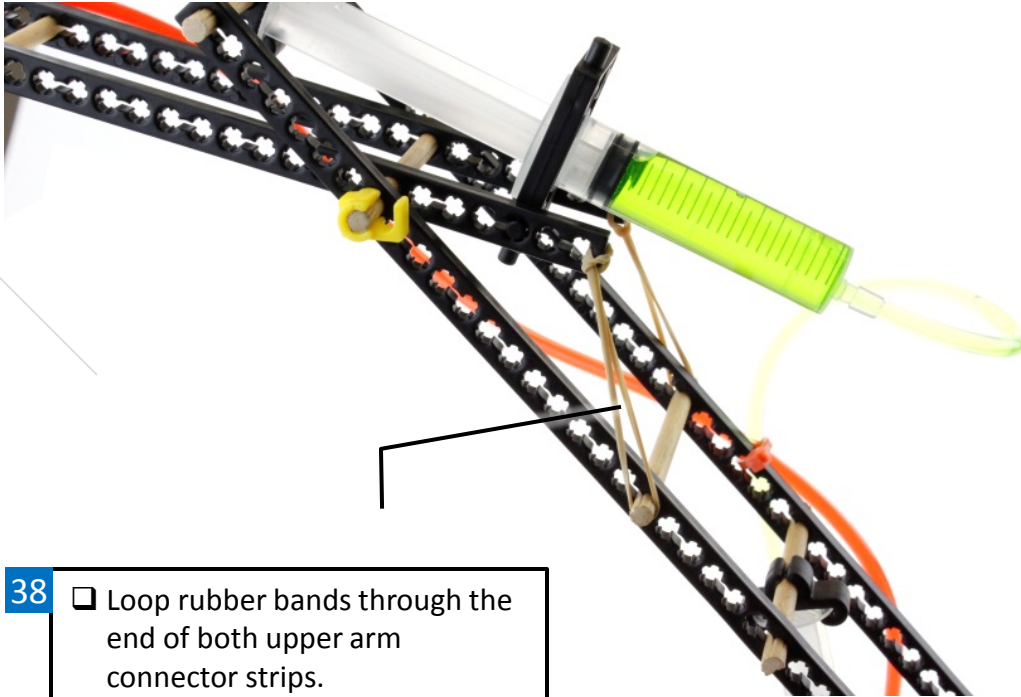

- 38**
- Loop rubber bands through the end of both upper arm connector strips.
 - Hook the other end of the rubber bands over the dowel extensions as shown.

- 39**
- Loop rubber bands through the end of both lower arm connector strips.
 - Ream the 8th hole down in the first vertical row of the hole plates (both sides).
 - Cut a 76mm (~3") dowel and insert into the reamed holes.
 - Hook the other end of the rubber bands over the dowel ends as shown.

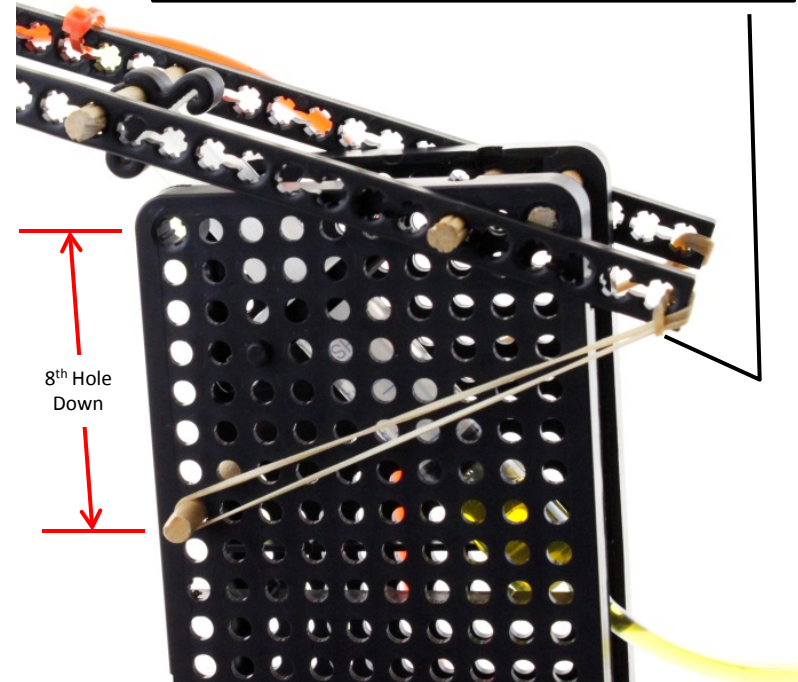

THE FINISHED HYDRAULIC ARM

